



KTM Core, KTM Prime

MINI, EASY, SPEEDY, ROBUST

Contrast sensors

SICK
Sensor Intelligence.

THE KTM CONTRAST SENSOR DETECTS PRINT MARKS QUICKLY AND RELIABLY



Small outside, quick inside: with fine grayscale resolution, high detection reliability on glossy media and quick response time, the KTM contrast sensor ensures quick packing, now with even greater process reliability.

A good eye for all print marks

No matter whether the print marks which trigger a switching signal are found on paper, glossy foil or other packaging materials, SICK contrast sensors are the perfect solution. SICK's 50 years of experience with contrast sensors have helped it to develop into the market leader, and, in the KTM, SICK now offers a particularly compact contrast sensor.

Perfect for the packaging industry

The main area of application for the KTM contrast sensor is in print mark recognition when controlling packaging processes, e.g., when cutting individual packaging from a pre-printed roll. Another aspect is the positioning or alignment of cans, tubes, labels, and pre-printed forms. No matter the situation, precise detection of the print mark ensures optimum packing and printing results.

COMPACT HOUSING SAVES SPACE, WITH A RANGE OF OPTIONS TO SOLVE MORE TASKS

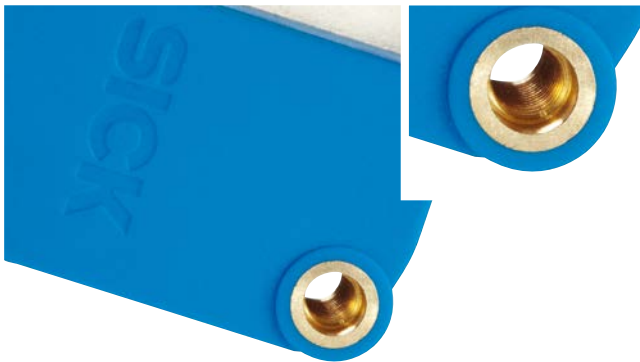

Easy to integrate due to miniature housing

Even where space is limited, at only 31.5 mm high the KTM allows for easy mounting. The rugged internally threaded metal inserts allow for a high tightening torque for securely fixed screws.

The sensor's high performance capability allows the housing to be mounted vertically above the medium. Laborious slanting processes for detection of glossy materials are only required in exceptional circumstances.



The perfect variant for any application

With the two product families KTM Core and KTM Prime, the KTM contrast sensor covers a variety of applications at a range of prices.

The KTM Core contrast sensor offers great performance for standard applications at a favorable price, with simple manual adjustment via an integrated potentiometer.

For more challenging applications, there is the high-performance KTM Prime contrast sensor. 3-color LED technology, convenient adjustments and an IO-Link interface characterize this contrast sensor.

The KTM Prime is now also available as an Inox variant for applications in harsh ambient conditions.

QUICKER PRODUCTION AND MORE EFFICIENT PACKAGING: KTM WITH QUICK RESPONSE TIME

The high-performance ASIC from SICK in the KTM contrast sensor makes it possible: Quick response times and a high dynamic range form the basis for precise switching signals, even under difficult conditions.



High-performance due to large dynamic range

Black/white or colored, matte or glossy – with the new ASIC in the KTM contrast sensor, print marks are reliably detected on an incredibly wide range of materials. This improved performance is particularly important for glossy materials such as highly reflective films and in the case of weak contrasts. For example, the sensors can deal with weaker saturated print marks that arise as a result of scanning or due to the use of low-contrast and pale colors.

High cycle for fast-moving processes

Particularly for processes that involve very high throughput speeds in packaging machinery and the graphics industry, a contrast sensor is used to transmit the required switch signals rapidly and precisely. With a response time of 35 μ s, the KTM is well-equipped for this. It can quickly and reliably detect the signal variation when the contrast mark has been passed, therefore ensuring high positioning accuracy even at high throughput speeds.

HIGH AVAILABILITY MACHINES DUE TO RELIABLE DETECTION OF PRINT AND CONTRAST MARKS

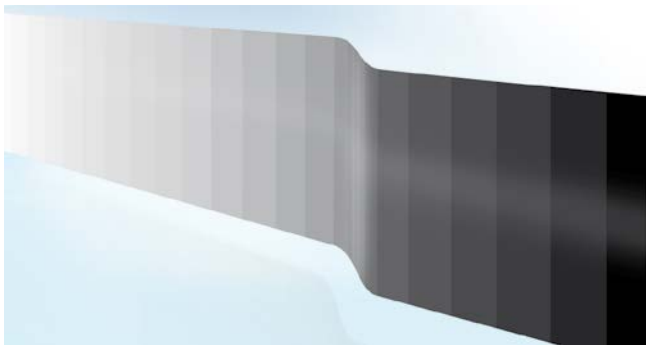

KTM detects fine intermediate shades

The KTM contrast sensor can even reliably achieve processes in which the print or contrast mark and the background are of similar brightness levels. In addition to differentiating between black and white, this sensor can also take a range of shades into account. Its fine resolution of 20 gray tones guarantees that even minimum levels of contrast are detected. This extends the application range of the mini contrast sensor to also include challenging applications.

PERFORMANCE AT A GREAT PRICE: KTM Core FOR STANDARD APPLICATIONS

A simple manual adjustment via an integrated potentiometer and the universal illumination with a white LED characterize the core versions of the KTM contrast sensor.

White light for print marks of all colors

A white LED is used as the universal emitted light for the KTM Core contrast sensor. Provided that the contrasts are high enough, a wide range of marks on the same background can be detected with the same switching threshold. One single setting is usually all that is needed. Core versions are sufficient for these applications, and offer high switching reliability at a very good price-performance ratio.

Easy adjustment of the switching threshold with potentiometer

In the event of product or format changes, the switching threshold of the core versions can be adjusted directly on the housing, quickly and easily, and without the need for tools.

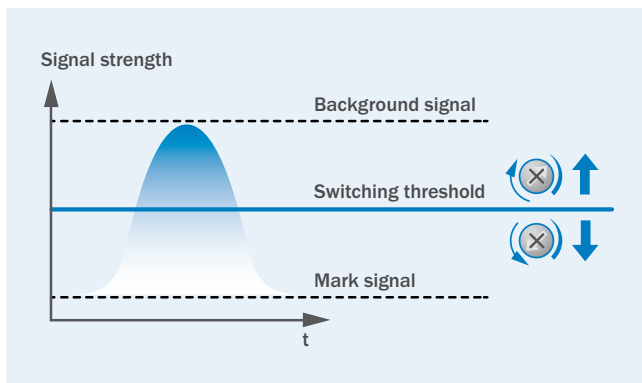

Versions of the KTM Core product family

- KTM Core: KTMxxxx91x
M8 male connector, 4-pin
For setting of the switching threshold manually when speed is of the essence.
- KTM Core: KTMxxxx11x
M8 male connector, 4-pin
For setting of the switching threshold using the screw-driver.



HIGH-PERFORMANCE AND CONVENIENT: KTM Prime CONTRAST SENSOR

The prime versions combine high detection reliability using 3-color LED technology with high productivity due to remote-controlled teach-in even during on-going production.

RGB-LED for more complex applications

For materials with high gloss and low contrasts in particular, the Prime versions of the KTM offer high detection reliability. This is because the sensor has red, green, and blue emitted light LEDs and carries out a fully-automatic check during teach-in to determine which LED generates the highest contrast value for the current process. Without making any other settings, the sensor therefore always works using the optimum emitted light. For this reason, the RGB LED is particularly suitable for any number of color combinations between marks and backgrounds. The KTM Prime is also available with white LED for special applications.

Teach-in with optimum efficiency

In addition to the simple static teach-in, all KTM Prime have two further teach-in features. "Dynamic teach-in" means teach-in performed by pressing the teach-in button during on-going operation, so that no interruption to the material flow is required. If you push the pushbutton again, the threshold is placed closer to the mark. The advantage is that the switching threshold does not always have to be readjusted even if the background changes. Dynamic teach-in is also suitable for remote adjustment on the control panel.

Versions of the KTM Prime product family

- KTM Prime: KTM-xxxxx81x
M8 male connector, 4-pin. PNP or NPN
- KTM Prime: KTM-xxxxxA1x
M8 male connector, 4-pin. With IO-Link. PNP or NPN
- KTM Prime: KTM-xxxxx82x
cable with M12 male connector, 4-pin. PNP or NPN
- KTM Prime Inox: KTM-xx1Ax82V
cable with M12 male connector, 4-pin, PNP or NPN
- KTM Prime Inox: KTM-xx1AxA2V
cable with M12 male connector, PNP, IO-Link



EVEN SUITED TO CRITICAL ENVIRONMENTS: KTM Prime Inox CONTRAST SENSOR



Process reliability in all environments: In the small, rugged and rust-free stainless steel housing and with IO-Link interface, the KTM Prime Inox contrast sensor, which is suitable for the most wide-ranging industrial applications, is impressive.

Optimum resistance

With the Inox sensor in the washdown design, the KTM Prime product family has a housing option which is optimally suitable for intensive cleaning and disinfection. Its chemical material resistance and absolute impermeability ensure very high availability even in harsh environments.

Impressive in the food and beverage industry

For the production of food and beverages, the KTM Prime Inox proves its high reliability and resistance in the wet environment of the machines and components. The real challenge, however, is the daily high-pressure cleaning of the systems, which represents high thermal and mechanical burdens. The KTM Prime Inox can be applied without a second thought wherever chemicals are used to prevent bacteria and microorganisms.

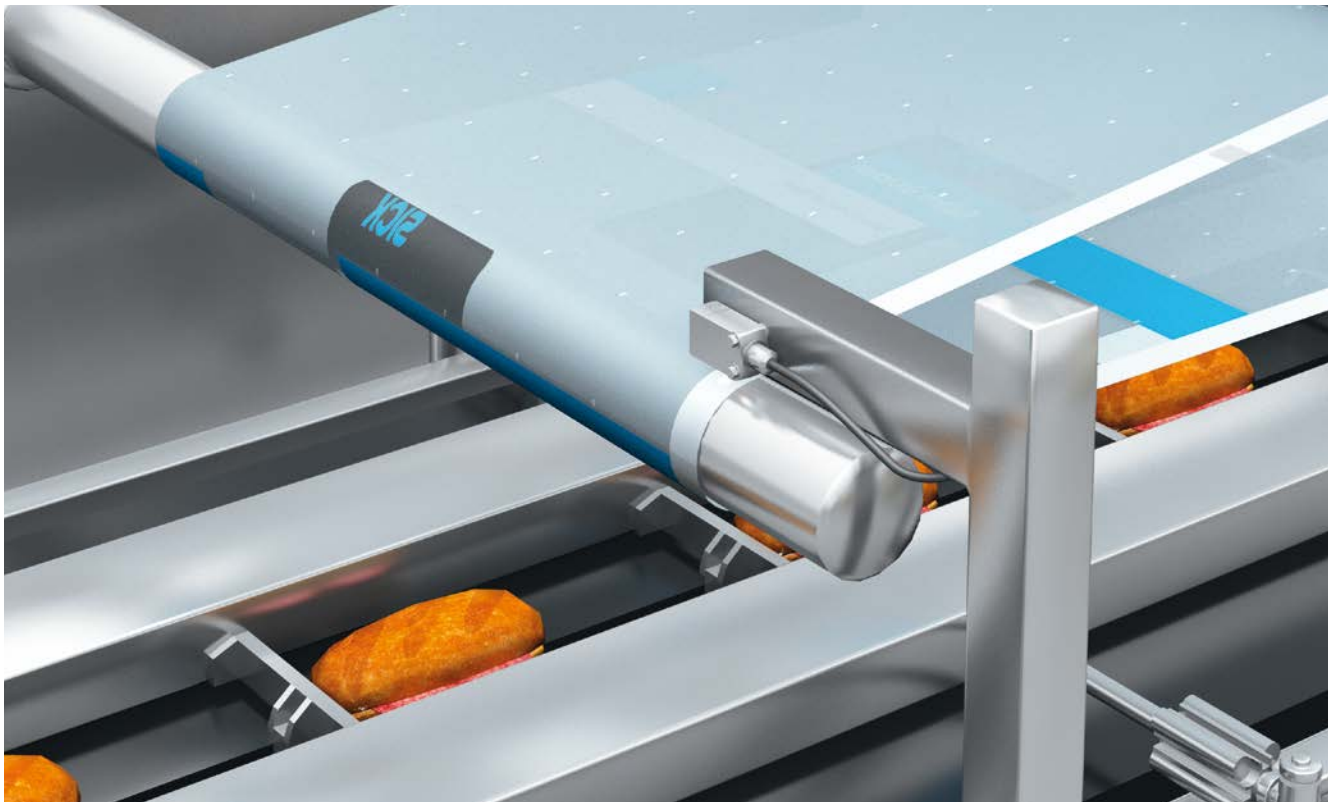

Smooth stainless steel housing

The V4A/316L alloy is extremely resistant, rust-free and long-life. Bacteria cannot cling to the smooth surfaces, and cleaning agents slowly drain off.

→ For highly aggressive cleaning



Recessed display LED

Display LEDs which have been recessed to be flush in the surface provide exceptionally bright illumination and are easily visible.

→ For lightning fast detection

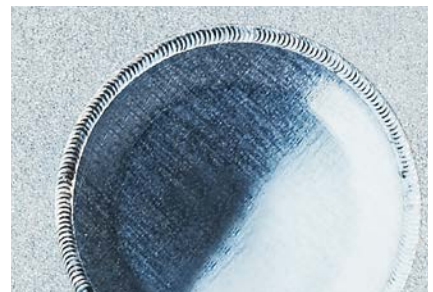

Easy operation as standard

Very convenient control via cable and/or flush integrated teach membrane for direct entry. IO-Link-enabled versions allow for flawless process monitoring

→ For incredibly convenient operation

SMART SENSOR SOLUTIONS – STANDARD FUNCTIONS WITH IO-LINK

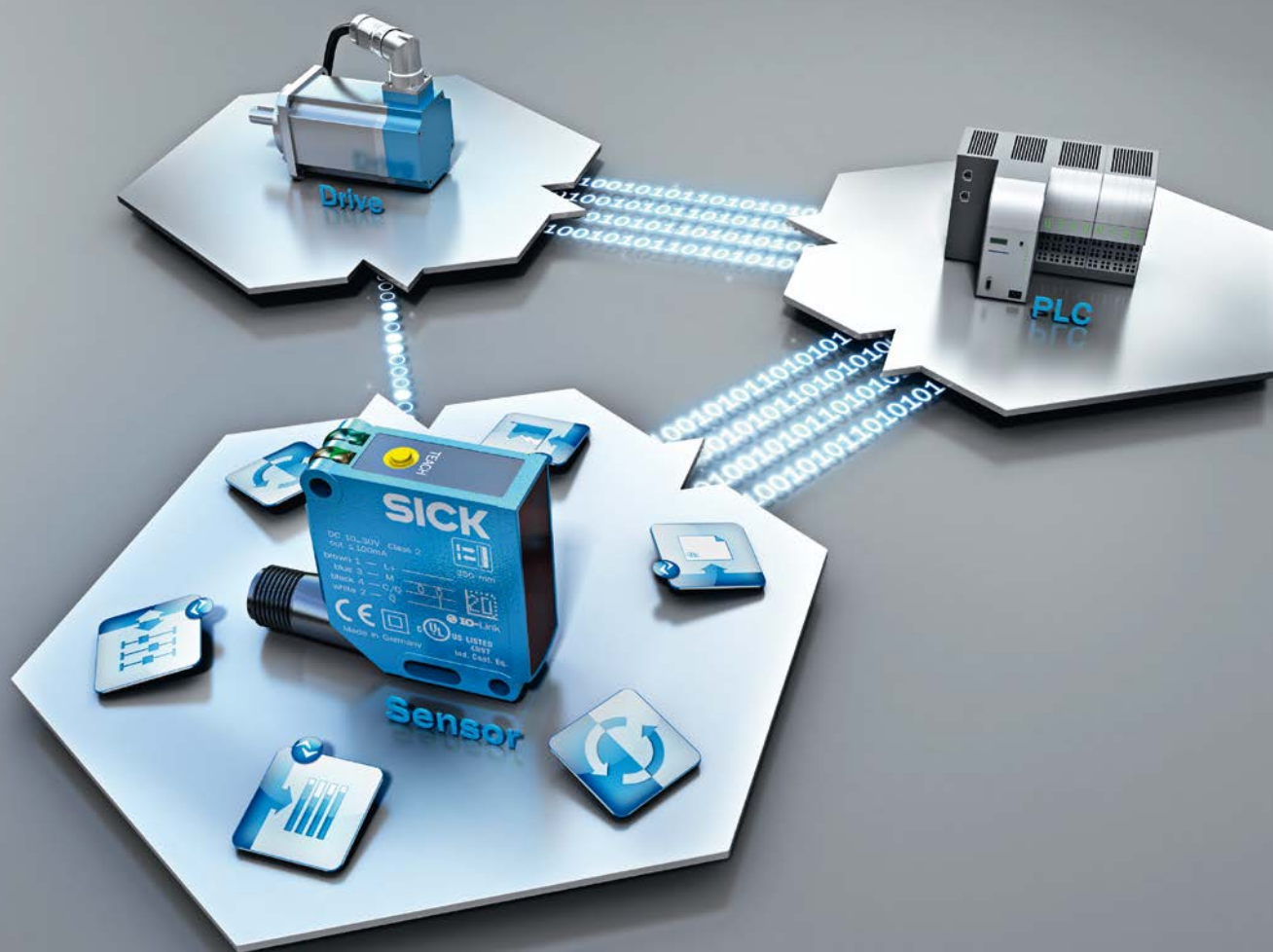

SICK sensors with IO-Link functions that can be integrated into an automation system offer a whole host of useful functions, from configuration and operation all the way through to monitoring. Even the standard functions go far beyond the scope of straightforward binary 0/1 switching signals.

OPTIMIZED AUTOMATION FOR MACHINES AND SYSTEMS



Condition monitoring / diagnostics

Implementing diagnostics and self-test options enables features such as contamination evaluation for sensors. Thanks to the monitoring capabilities of the sensors, preventive maintenance can be carried out using a precise maintenance plan. This ability to predict machine status even extends across area boundaries. The advantages of this are reduced maintenance and repair times, minimal risk of failure, as well as accurate fault localization and diagnostics.



E-parts list / E-inventory

IO-Link enables the electronic documentation for all sensors in the machine or system's as-delivered state to be created quickly and using an automated method. The advantages of this are increased transparency in the electronic documentation for installed sensors, cables, and male connectors. This prevents time-consuming troubleshooting processes that result from different versions of documentation. What is more, the machine or system's as-delivered state can be documented easily and accurately in this way.



Sensor visualization

Sensor data such as the device ID, serial number, teach-in values, hysteresis or switching behavior can be displayed and modified using visualization software and the SiLink Box on a PC. All parameters can be optimized and transferred to multiple sensors.

The advantages of this are:

- Comprehensive diagnostics options
- Availability values can be checked and parameters can be optimized
- Simplified range of function and performance options available for selection
- Quick and safe sensor pre-configuration
- Easy identification of optimized application parameters
- Simple commissioning



Flexible sensor adjustment

An IO-Link sensor receives optimized, application-specific parameters (such as the scanning distance, hysteresis or threshold) from the automation system according to the production process or the product that is to be produced. The advantages of this are reduced machine downtimes and changeover times when switching products, more machine flexibility, and the prevention of incorrect settings.



Easy device replacement

Sensors with IO-Link can be replaced quickly and easily, as they are able to adopt the set function parameters without any alterations. The parameters are stored in the IO-Link master or in the control system. The advantages of this are minimal downtimes, guaranteed machine availability, as well as recorded and documented replacement processes.

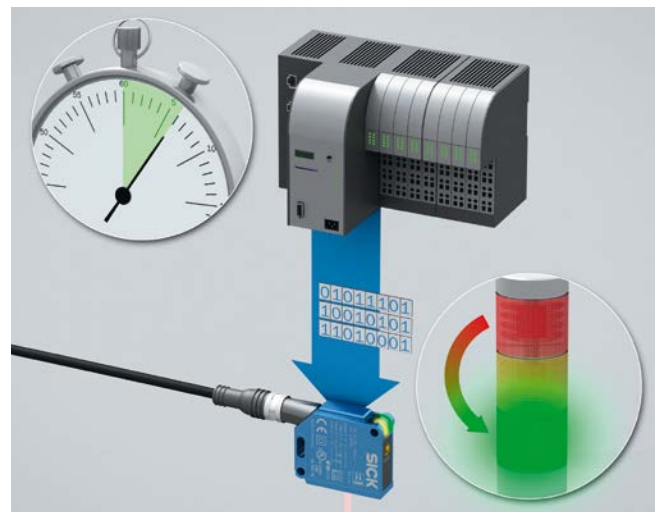

MINI, EASY, SPEEDY



Product description

Top performance for universal, space-saving use in the packaging industry: The new KTM core contrast sensor from SICK features a high grayscale resolution and is integrated into a small, tried-and-tested housing. The optimized OES4 ASIC technology and a response time of 50 µs ensure reliable and ac-

curate detection of contrast marks, even on glossy materials. The easy adjustment method ensures greater flexibility during commissioning. The KTM reliably detects marks even in conditions with weak contrast ratios and is therefore ideal for use in a wide range of applications.

At a glance

- Small, tried-and tested housing
- High grayscale resolution
- Very large dynamic range means reliable detection of contrasts on glossy materials
- Switching frequency: 10 kHz
- White light

Your benefits

- Small housing allows installation even where space is limited
- Powerful, fast contrast sensor ensures high machine throughput
- Good contrast resolution and a very large dynamic range ensure good detection performance on glossy materials, thus increasing the range of application possibilities
- Quick and easy configuration



Additional information

Detailed technical data 13
 Ordering information 14
 Dimensional drawings 14
 Adjustments 15
 Connection type and diagram 15
 Sensing distance 15
 Setting the switching threshold 15
 Recommended accessories 22

→ www.mysick.com/en/KTM_Core

For more information, just enter the link or scan the QR code and get direct access to technical data, CAD design models, operating instructions, software, application examples and much more.



Detailed technical data

Features

| | |
|---|-------------------------|
| Dimensions (W x H x D) | 31.5 mm x 21 mm x 12 mm |
| Sensing distance | 12.5 mm |
| Sensing distance tolerance | ± 3 mm |
| Light source ¹⁾ | LED |
| Max. web speed tech-in (dynamic) ²⁾ | 1 m/s |
| Output function | Light/dark switching |

¹⁾ Average service life of 100,000 h at $T_A = +25\text{ °C}$.

²⁾ At a mark size of 4 mm.

Mechanics/electronics

| | |
|--|--|
| Supply voltage ¹⁾ | 12 V DC ... 24 V DC |
| Ripple ²⁾ | ≤ 5 V _{pp} |
| Power consumption ³⁾ | < 50 mA |
| Switching output | PNP: HIGH = $V_S - \leq 2\text{ V}$ / LOW approx. 0 V NPN: HIGH = approx. V_S / LOW ≤ 2 V |
| Output current I_{max.} ⁴⁾ | 50 mA |
| Retention time (ET) | 28 ms, non-volatile memory |
| Protection class | III |
| Circuit protection | V_S connections reverse-polarity protected Output Q short-circuit protected Interference suppression |
| Enclosure rating | IP 67 |
| Weight | |
| Connector M8, 4-pin | 20 g |
| Cable with connector M12, 4-pin | 70 g |
| Housing material | Plastic, ABS |

¹⁾ Limit values: DC 12 V (-10 %) ... DC 24 V (+20 %). Operation in short-circuit protected network max. 8 A.

²⁾ May not exceed or fall short of V_S tolerances.

³⁾ Without load.

⁴⁾ At supply voltage > 24 V, $I_{max} = 30\text{ mA}$. I_{max} is consumption count of all Q_n .

Ambient data

| | |
|--------------------------------------|------------------------------|
| Ambient operating temperature | -10 °C ... +55 °C |
| Ambient storage temperature | -20 °C ... +75 °C |
| Shock load | According to IEC 60068 |
| UL File No. | |
| Connector M8, 4-pin | NRKH.E348498 & NRKH7.E348498 |
| Cable with connector M12, 4-pin | NRKH.E348498 |

Ordering information

KTM Core

- **Light spot direction:** -
- **Response time:** 50 μ s (Signal transit time with resistive load.)
- **Switching frequency:** 10 kHz (With light/dark ratio 1:1.)

| Type of light | Light spot size | Adjustment | Connection type | Switching output | Type | Part no. |
|---------------------|-----------------|-----------------------------|---------------------|------------------|--------------|----------|
| Visible white light | 1 mm x 1 mm | Potentiometer, manual | Connector M8, 4-pin | PNP, NPN | KTM-MB8A191P | 1066885 |
| | 2 mm x 2 mm | Potentiometer, manual | Connector M8, 4-pin | PNP, NPN | KTM-MB31191P | 1062203 |
| | | Potentiometer, screw driver | Connector M8, 4-pin | PNP, NPN | KTM-MB31111P | 1062202 |

Dimensional drawings (Dimensions in mm (inch))

KTM-xBxxx91x

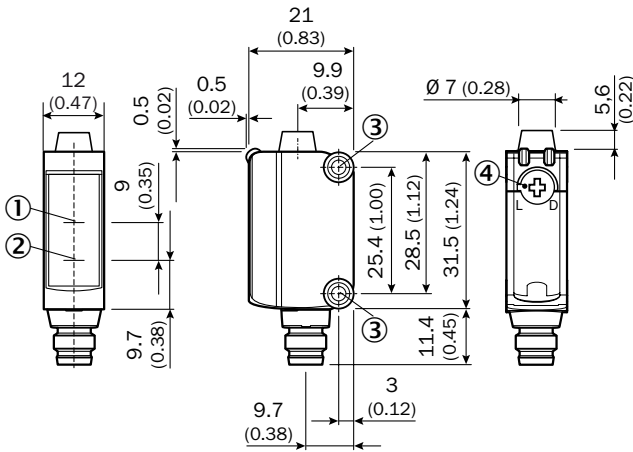

- ① Optical axis receiver
- ② Optical axis sender
- ③ Fixing hole M3
- ④ Light/ dark rotary switch:L = light switching, D = dark switching

KTM-xBxxx11x

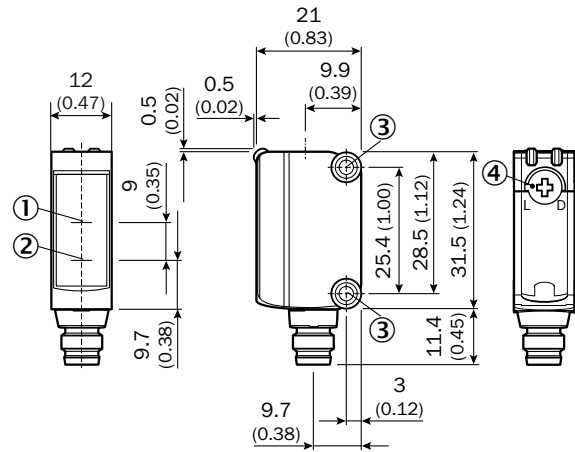

- ① Optical axis receiver
- ② Optical axis sender
- ③ Fixing hole M3
- ④ Light/ dark rotary switch:L = light switching, D = dark switching

Adjustments

KTM Core

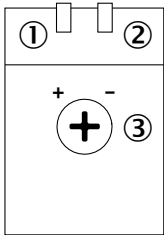

- ① Status indicator LED, yellow: Status switching output Q (dark switching)
- ② Status indicator LED green: power on
- ③ Switching threshold adjustment

Connection type and diagram

KTM-xxxxxx1x

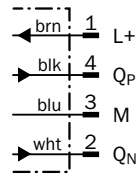
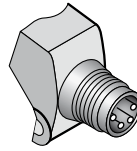

Sensing distance

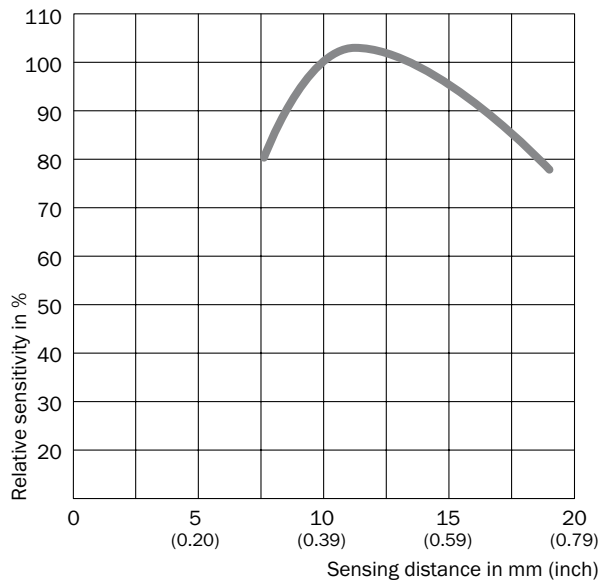

Setting the switching threshold via potentiometer

For example dark switching

1. Position background

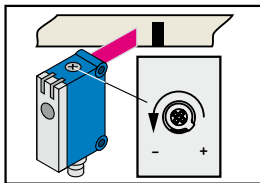

Start at "+" (right-hinged).
Turn potentiometer in direction "-" until the yellow LED goes out.

2. Position mark

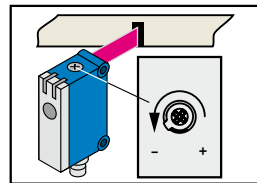

Yellow LED lights up.
Continue to turn the potentiometer in direction "-" until the yellow LED goes out again.

3. Set switching threshold

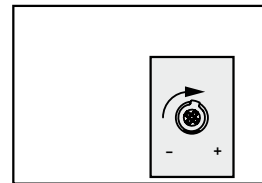

Turn between positions 1 and 2, to ensure that the switching threshold is optimally set.

Switching characteristics

The switching threshold is set in the center between the background and the mark.

Light switching: yellow LED ≠ switching output Q

Dark switching: yellow LED = switching output Q

Light/dark switching selectable by means of rotary switch

KTM-xBxxx1xx: potentiometer can be adjusted with a screwdriver

KTM-xBxxx9xx: potentiometer can be adjusted with a screwdriver or by hand

MINI, EASY, SPEEDY, RUGGED

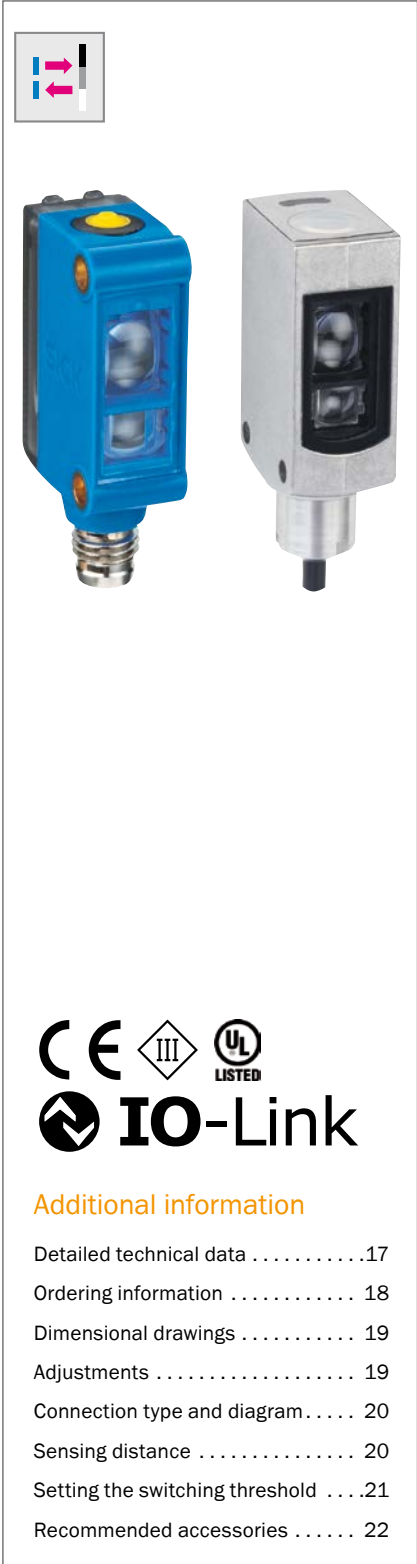

Product description

Top performance for universal, space-saving use in the packaging industry even under harsh conditions: The new KTM prime contrast sensor from SICK features a high grayscale resolution and is integrated into a small, tried-and-tested housing that is also available in stainless steel. The optimized OES4 ASIC technology and a response time of 35 μ s ensure reliable and accurate detection of contrast marks, even on glossy materials. The various teach-in methods

(dynamic, static, and switching threshold near the marks) ensure greater flexibility during commissioning. The integrated IO-Link interface can be used to access the parameter settings. This speeds up and simplifies format changes. The KTM reliably detects marks even in conditions with weak contrast ratios and is therefore ideal for use in a wide range of applications; in the stainless steel version, it can even be used in harsh environments during intensive cleaning.

At a glance

- Small, tried-and-tested housing, also available in stainless steel
- High grayscale resolution
- Very large dynamic range means reliable detection of contrasts on glossy materials
- Static and dynamic teach-in
- Switching frequency: 15 kHz
- RGB light source
- Remote monitoring and rapid analysis thanks to IO-Link function (version 1.1)

Your benefits

- Small housing allows installation even where space is limited
- Powerful, fast contrast sensor ensures high machine throughput
- Three-color LED technology allows a reliable process, with contrast marks detected even in conditions with weak contrast ratios
- Good contrast resolution and a very large dynamic range ensure good detection performance on glossy materials, thus increasing the range of application possibilities
- Various teach-in methods enable more flexible commissioning
- Enhanced diagnostics and visualization of sensor parameters, as well as quick and easy format changes, since parameter settings can be downloaded via IO-Link
- IO-Link provides easy data access from the PLC
- Quick and easy configuration
- Long service life, even in harsh environments, thanks to stainless steel housing; as a result, excellent system throughput and low spare parts costs

Additional information

Detailed technical data17
 Ordering information 18
 Dimensional drawings 19
 Adjustments 19
 Connection type and diagram 20
 Sensing distance 20
 Setting the switching threshold21
 Recommended accessories 22

→ www.mysick.com/en/KTM_Prime

For more information, just enter the link or scan the QR code and get direct access to technical data, CAD design models, operating instructions, software, application examples and much more.



Detailed technical data

Features

| | KTM Prime | KTM Prime Inox |
|---|-------------------------|------------------------------|
| Dimensions (W x H x D) | 31.5 mm x 21 mm x 12 mm | 48.6 mm x 22.2 mm x 15.25 mm |
| Sensing distance | 12.5 mm | 11 mm |
| Sensing distance tolerance | ± 3 mm | |
| Light source ¹⁾ | LED | |
| Wave length | 470 nm, 525 nm, 625 nm | |
| Max. web speed tech-in (dynamic) ²⁾ | 1 m/s | |
| Output function | Light/dark switching | |

¹⁾ Average service life of 100,000 h at $T_A = +25$ °C.

²⁾ At a mark size of 4 mm.

Mechanics/electronics

| | KTM Prime | KTM Prime Inox |
|--|---|----------------------|
| Supply voltage ¹⁾ | 12 V DC ... 24 V DC | |
| Ripple ²⁾ | ≤ 5 V _{pp} | |
| Power consumption ³⁾ | < 50 mA | |
| Switching output | PNP: HIGH = $V_S - \leq 2$ V / LOW approx. 0 V NPN: HIGH = approx. V_S / LOW ≤ 2 V | |
| Output current I_{max.} ⁴⁾ | 50 mA | |
| Input, teach-in (ET) | PNP: Teach: U = 10,8 V ... < U _v Run: U < 2 V or open NPN: Teach: U < 2 V Run: U _v - 2 V or open | |
| Retention time (ET) | 28 ms, non-volatile memory | |
| Protection class | III | |
| Circuit protection | V _S connections reverse-polarity protected Output Q short-circuit protected Interference suppression | |
| Enclosure rating | IP 67 | IP 67, IP 69K |
| Weight | | |
| Connector M8, 4-pin | 20 g | - |
| Cable with connector M12, 4-pin | 70 g | |
| Housing material | Plastic, ABS | stainless steel 316L |

¹⁾ Limit values: DC 12 V (-10 %) ... DC 24 V (+20 %). Operation in short-circuit protected network max. 8 A.

²⁾ May not exceed or fall short of V_S tolerances.

³⁾ Without load.

⁴⁾ At supply voltage > 24 V, I_{max} = 30 mA. I_{max} is consumption count of all Q_n.

Ambient data

| | KTM Prime | KTM Prime Inox |
|--------------------------------------|------------------------------|-------------------|
| Ambient operating temperature | -10 °C ... +55 °C | -30 °C ... +70 °C |
| Ambient storage temperature | -20 °C ... +75 °C | -30 °C ... +75 °C |
| Shock load | According to IEC 60068 | |
| UL File No. | | |
| Connector M8, 4-pin | NRKH.E348498 & NRKH7.E348498 | - |
| Cable with connector M12, 4-pin | NRKH.E348498 | |

Ordering information

KTM Prime

- **Light spot direction:** vertical
- **Response time:** 35 µs (Signal transit time with resistive load.)
- **Switching frequency:** 15 kHz (With light/dark ratio 1:1.)

| Type of light | Light spot size | Adjustment | Connection type | Switching output | Type | Part no. |
|--|-----------------|---|---------------------------------|------------------|--------------|----------|
| White light | 2 mm x 2 mm | 2-point teach-in static/ dynamic + proximity to mark | Connector M8, 4-pin | PNP | KTM-MP31181P | 1065756 |
| | | | | NPN | KTM-MN31181P | 1071947 |
| | | | Cable with connector M12, 4-pin | PNP, IO-Link | KTM-MP317A1P | 1071482 |
| | | | | PNP | KTM-MP31182P | 1070490 |
| Red light, green light, blue light | 1.5 mm x 6.5 mm | 2-point teach-in static/ dynamic + proximity to mark | Connector M8, 4-pin | PNP | KTM-WP11181P | 1062199 |
| | | | | NPN | KTM-WN11181P | 1062200 |
| | | | | PNP, IO-Link | KTM-WP117A1P | 1061770 |
| | | | Cable with connector M12, 4-pin | NPN, IO-Link | KTM-WN117A1P | 1061787 |
| | | | | PNP | KTM-WP11182P | 1062201 |
| | | | | NPN | KTM-WN11182P | 1062150 |

KTM Prime Inox

- **Light spot direction:** vertical
- **Response time:** 35 µs (Signal transit time with resistive load.)
- **Switching frequency:** 15 kHz (With light/dark ratio 1:1.)

| Type of light | Light spot size | Adjustment | Connection type | Switching output | Type | Part no. |
|--|-----------------|--|---------------------------------|------------------|--------------|----------|
| Red light, green light, blue light | 1.5 mm x 6.5 mm | 2-point teach-in static/dy- namic + proximity to mark | Cable with connector M12, 4-pin | PNP | KTM-WP1A182V | 1052956 |
| | | | | NPN | KTM-WN1A182V | 1062148 |
| | | | | PNP, IO-Link | KTM-WP1A7A2V | 1062147 |

Dimensional drawings (Dimensions in mm (inch))

KTM Prime

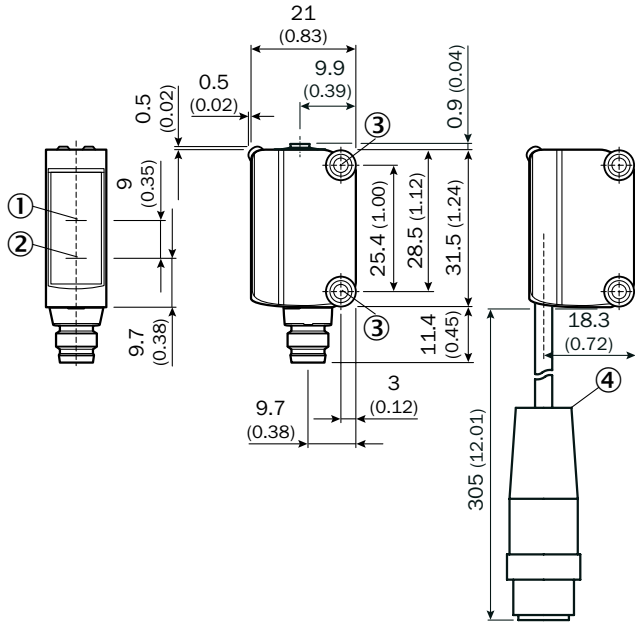

- ① Optical axis receiver
- ② Optical axis sender
- ③ Fixing hole M3
- ④ Cable with connector (only KTM-xxxxx2x)

KTM Prime Inox

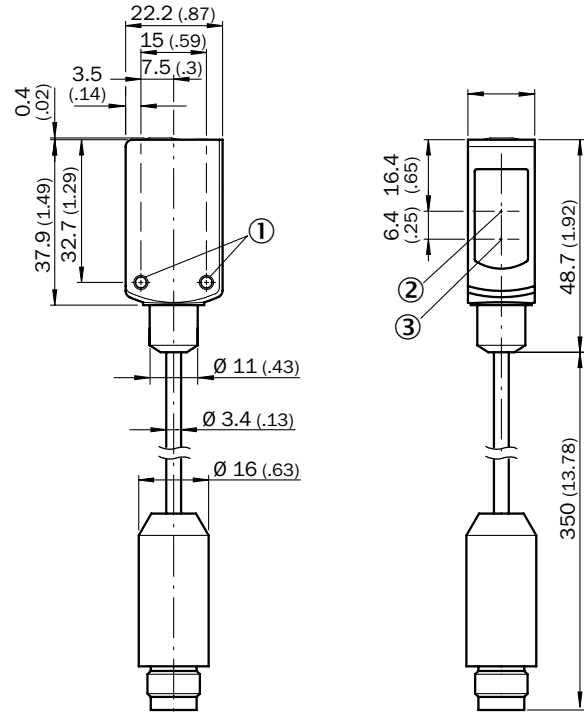

- ① Fixing hole M3
- ② Optical axis receiver
- ③ Optical axis sender

Adjustments

KTM Prime

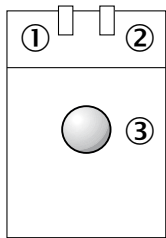

- ① Status indicator LED, yellow: Status switching output Q (dark switching)
- ② Status indicator LED green: power on
- ③ Teach-in button

KTM Prime Inox

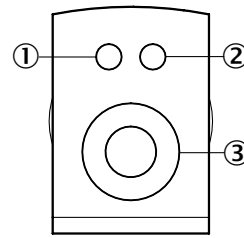

- ① Status indicator LED, yellow: Status switching output Q
- ② Status indicator LED green: power on
- ③ Teach-in button

Connection type and diagram

KTM-xxxxx81x

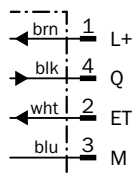
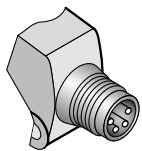

KTM-xxxxxA1x IO-Link

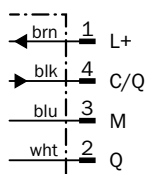
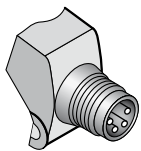

KTM-xxxxx82x

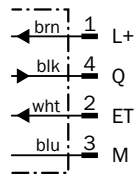
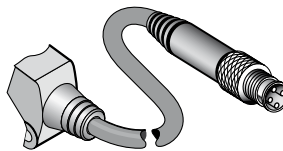

KTM-xxxxxA2x IO-Link

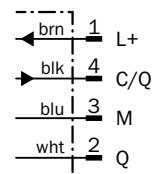
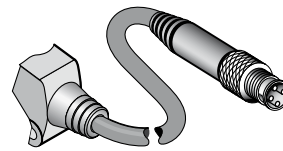

Sensing distance

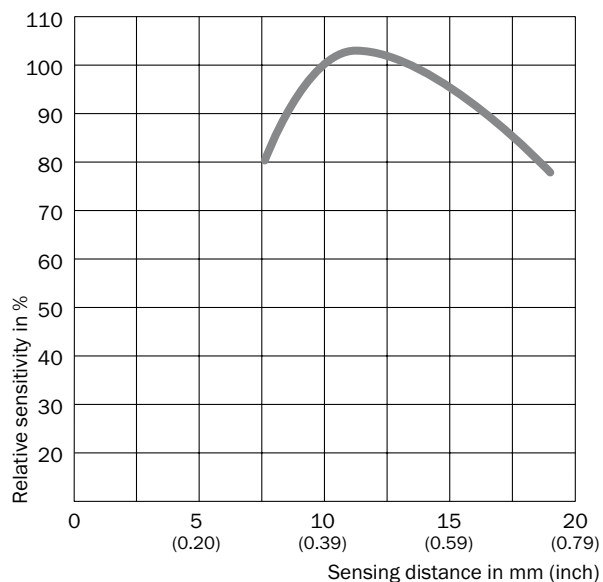

Setting the switching threshold via teach-in (static 2-point teach-in)

1. Position mark

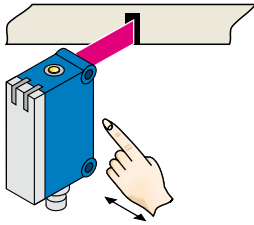

Press and hold teach-in button $> 1 < 3$ s.
Yellow LED flashes slowly.

2. Position background

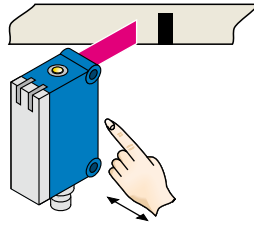

Press and hold teach-in button < 3 s.
Yellow LED goes out.

Setting the switching threshold via teach-in (dynamic)

1. Position background

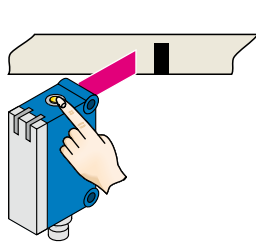

Press the teach-in button and keep it pressed. LED flashing slowly.

2. Move at least the mark and background using the light spot.

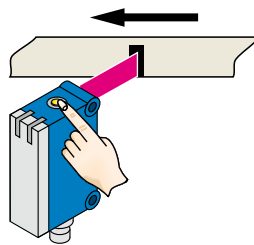

Keep the teach-in button $> 3 < 30$ s pressed.

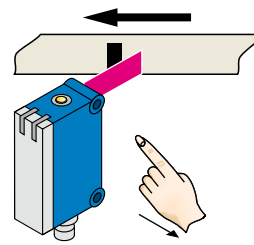

Release the teach-in button.

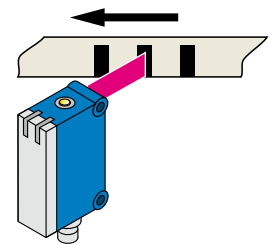

Yellow LED will illuminate, when emitted light is on the mark.

Example

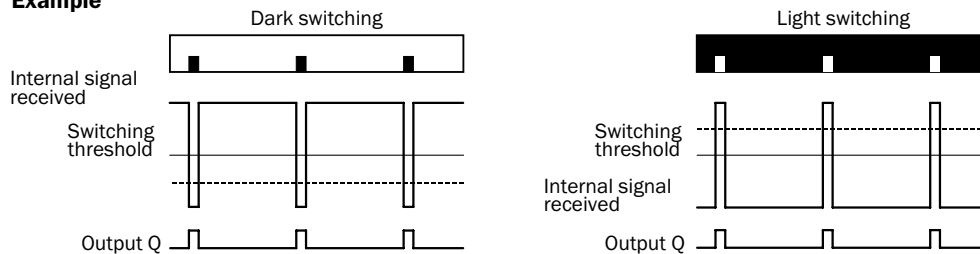

Switching characteristics

The optimum emitted light is selected automatically (at RGB variants).

Static teach-in: light/dark setting is defined using teach-in sequence.

Dynamic teach-in: switching output active on mark, if background is longer in the field of view during the teach-in.

The switching threshold is set in the center between the background and the mark.

If the button is pressed again within 10 s of the teach (> 20 ms < 10 s), the relative switching threshold

is placed 75 % between mark (100 %) and background (0 %) (dotted line in Figure).

Teach-in can also be performed using an external control signal (only dynamic teach-in).

Keylock activation and deactivation: hold down teach-in button > 30 s.

Teach-in failure: yellow LED indicator and the transmitted light of the sensor flashing quickly.

For dynamic teach-in with ET signal (5 Hz) via switching output Q.



Recommended accessories

Universal bar clamp systems

| Figure | Material | Description | Model name | Part no. | KTM | KTM Inox |
|---|--|--|--------------|----------|-----|----------|
|  | Steel, zinc coated | Universal clamp bracket for rod mounting | BEF-KHS-KH1 | 2022726 | ● | ● |
|  | Steel, zinc coated | Plate L for universal clamp bracket | BEF-KHS-L01 | 2023057 | ● | ● |
|  | Zinc plated steel (sheet), Diecast zinc (clamp) | Plate N08 for universal clamp bracket | BEF-KHS-N08 | 2051607 | ● | ● |
| | Stainless steel 1.4571 (sheet), Stainless steel 1.4408 (clamp) | Plate N08N for universal clamp bracket | BEF-KHS-N08N | 2051616 | ● | ● |
|  | Steel, zinc coated | Mounting bar, straight, 200 mm, steel | BEF-MS12G-A | 4056054 | ● | ● |
| | | Mounting bar, straight, 300 mm, steel | BEF-MS12G-B | 4056055 | ● | ● |
|  | Steel, zinc coated | Mounting bar, L-shaped, 150 mm x 150 mm, steel | BEF-MS12L-A | 4056052 | ● | ● |
| | | Mounting bar, L-shaped, 250 x 250 mm, steel | BEF-MS12L-B | 4056053 | ● | ● |

Mounting brackets and mounting plates

Mounting brackets

| Figure | Material | Description | Model name | Part no. | KTM | KTM Inox |
|---|--------------------|-------------------------------------|------------|----------|-----|----------|
|  | Stainless steel | Mounting bracket for wall mounting | BEF-W100-A | 5311520 | ● | ● |
|  | Steel, zinc coated | Mounting bracket for floor mounting | BEF-W100-B | 5311521 | ● | ● |



Mounting plates

| Figure | Material | Description | Model name | Part no. | KTM | KTM Inox |
|---|-----------------|--------------------------|---------------|----------|-----|----------|
|  | Stainless steel | Adapter plate KT3 to KTM | BEF-AP-KTMS01 | 2068786 | ● | ● |



Plug connectors and cables

Connecting cables with female connector

M12, 4-pin, PVC



| Figure | Connection type head A | Connection type head B | Connecting cable | Model name | Part no. | KTM | KTM Inox |
|---|--|-----------------------------|------------------|---------------|----------|-----|----------|
|  | Female connector, M12, 4-pin, straight, unshielded | Cable, open conductor heads | 2 m, 4-wire | DOL-1204-G02M | 6009382 | ● | ● |
| | | | 5 m, 4-wire | DOL-1204-G05M | 6009866 | ● | ● |
|  | Female connector, M12, 4-pin, angled, unshielded | Cable, open conductor heads | 2 m, 4-wire | DOL-1204-W02M | 6009383 | ● | ● |
| | | | 5 m, 4-wire | DOL-1204-W05M | 6009867 | ● | ● |

M8, 4-pin, PVC



| Figure | Connection type head A | Connection type head B | Connecting cable | Model name | Part no. | KTM | KTM Inox |
|---|---|-----------------------------|------------------|---------------|----------|-----|----------|
|  | Female connector, M8, 4-pin, straight, unshielded | Cable, open conductor heads | 2 m, 4-wire | DOL-0804-G02M | 6009870 | ● | - |
| | | | 5 m, 4-wire | DOL-0804-G05M | 6009872 | ● | - |
|  | Female connector, M8, 4-pin, angled, unshielded | Cable, open conductor heads | 2 m, 4-wire | DOL-0804-W02M | 6009871 | ● | - |
| | | | 5 m, 4-wire | DOL-0804-W05M | 6009873 | ● | - |

Female connectors (ready to assemble)

M12, 4-pin

| Figure | Connection type head A | Connection type head B | Model name | Part no. | KTM | KTM Inox |
|---|--|------------------------|------------|----------|-----|----------|
|  | Female connector, M12, 4-pin, straight, unshielded | Screw-type terminals | DOS-1204-G | 6007302 | ● | ● |
|  | Female connector, M12, 4-pin, angled, unshielded | Screw-type terminals | DOS-1204-W | 6007303 | ● | ● |

M8, 4-pin

| Figure | Connection type head A | Connection type head B | Model name | Part no. | KTM | KTM Inox |
|---|---|------------------------|------------|----------|-----|----------|
|  | Female connector, M8, 4-pin, straight, unshielded | Screw-type terminals | DOS-0804-G | 6009974 | ● | - |
|  | Female connector, M8, 4-pin, angled, unshielded | Screw-type terminals | DOS-0804-W | 6009975 | ● | - |

Universal bar clamp systems

BEF-KHS-KH1

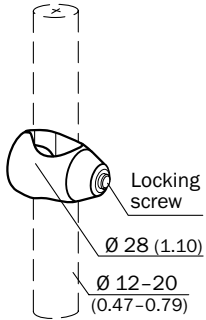

BEF-KHS-L01

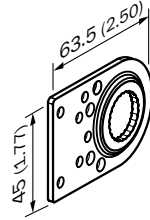

BEF-KHS-N08 / BEF-KHS-N08N

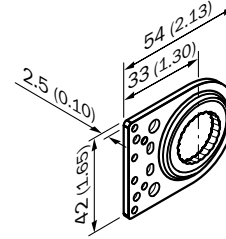

BEF-MS12G-A / BEF-MS12G-B

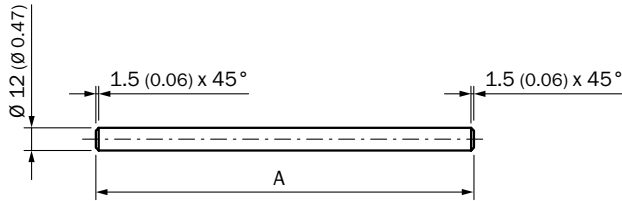

- ① BEF-MS12G-(N)A: A = 200 mm
- ② BEF-MS12G-(N)B: A = 300 mm

BEF-MS12L-A / BEF-MS12L-B

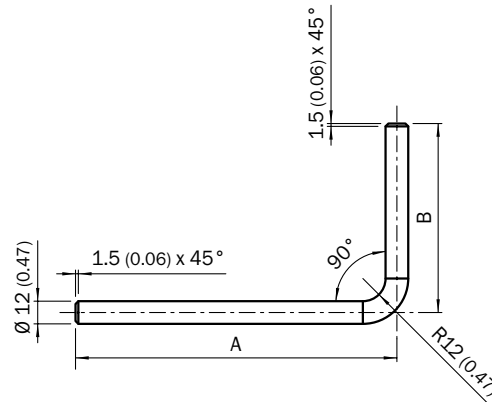

- ① BEF-MS12L-(N)A: A = 200 mm, B = 150 mm
- ② BEF-MS12L-(N)B: A = 250 mm, B = 250 mm

Mounting brackets and mounting plates

Mounting brackets

BEF-W100-A

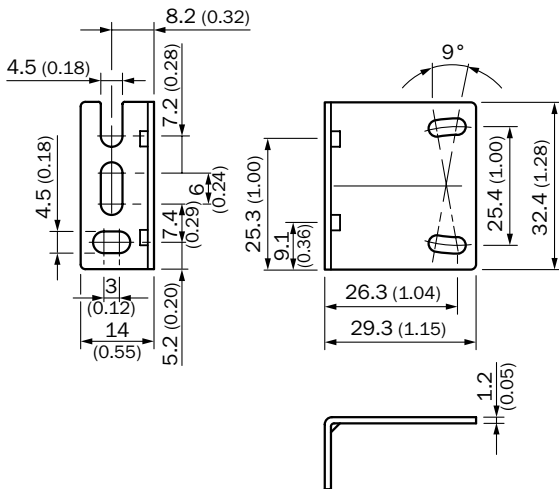

BEF-W100-B

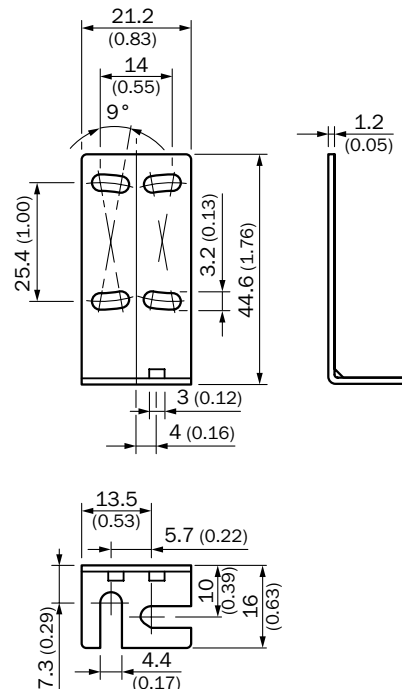

Mounting plates

BEF-AP-KTMS01

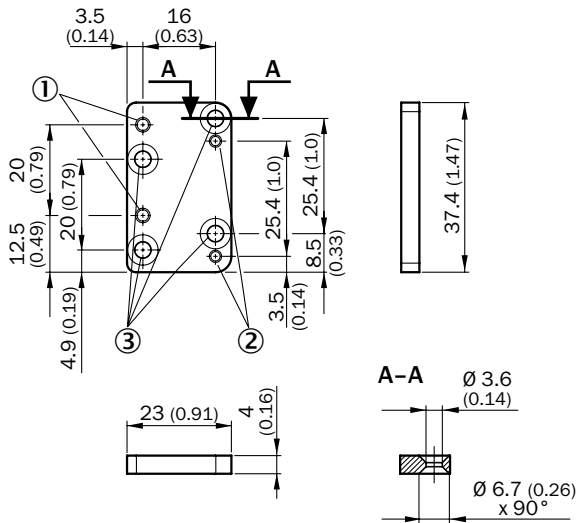

- ① Threaded mounting hole M3
- ② Threaded mounting hole M2.5
- ③ Fixing hole M3

Plug connectors and cables

connecting cables with female connector

M12, 4-pin, PVC

DOL-1204-GxxM

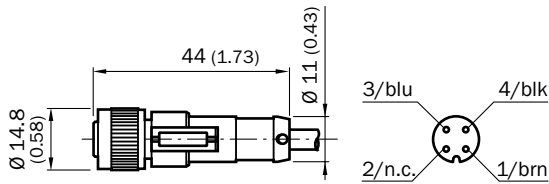

DOL-1204-WxxM

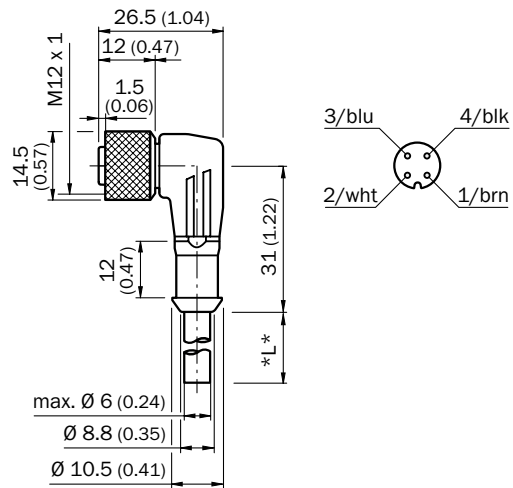

M8, 4-pin, PVC

DOL-0804-GxxM

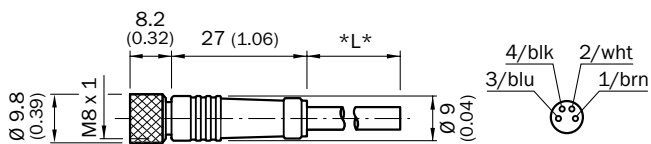

DOL-0804-WxxM

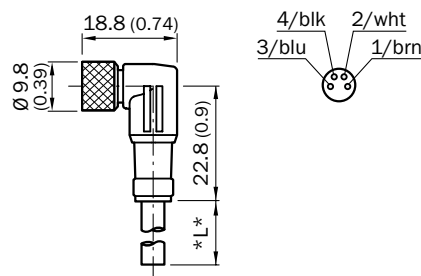

Female connectors (ready to assemble)

M12, 4-pin

DOS-1204-G

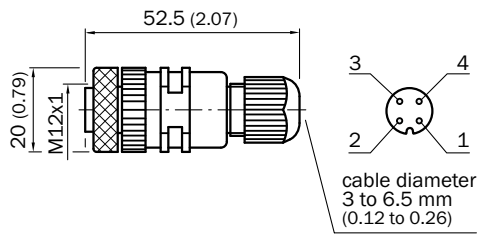

DOS-1204-W

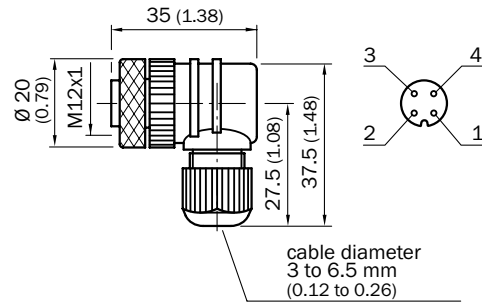

M8, 4-pin

DOS-0804-G

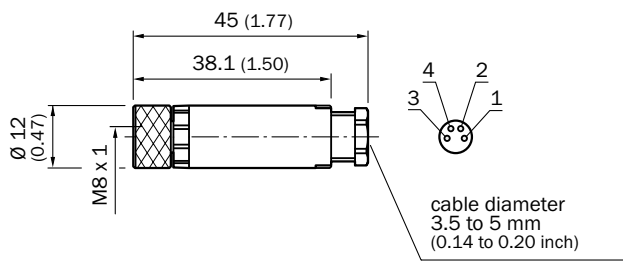

DOS-0804-W

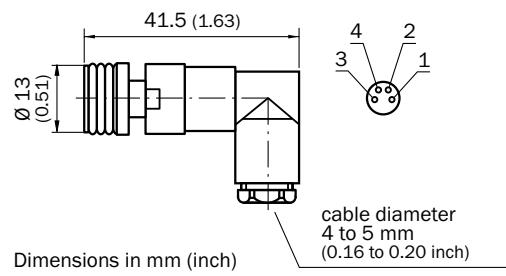

WWW.MYSICK.COM – SEARCH ONLINE AND ORDER

Search online quickly and safely - with the SICK "Finders"

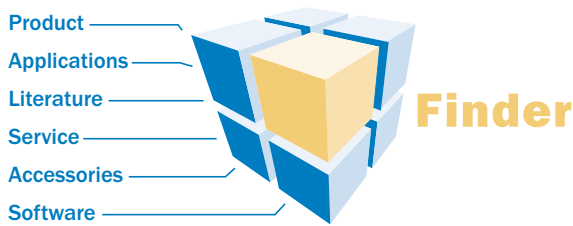

Product Finder: We can help you to quickly target the product that best matches your application.

Applications Finder: Select the application description on the basis of the challenge posed, industrial sector, or product group.

Literature Finder: Go directly to the operating instructions, technical information, and other literature on all aspects of SICK products.

Efficiency – with the E-Commerce-Tools from SICK

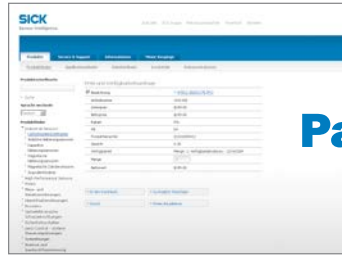

Partner Portal
www.mysick.com

Find out prices and availability

Determine the price and possible delivery date of your desired product simply and quickly at any time.

Request or view a quote

You can have a quote generated online here. Every quote is confirmed to you via e-mail.

Order online

You can go through the ordering process in just a few steps.

FOR SAFETY AND PRODUCTIVITY: SICK LIFETIME SERVICES

SICK LifeTime Services is a comprehensive set of high-quality services provided to support the entire life cycle of products and applications from system design all the way to upgrades. These services increase the safety of people, boost the productivity of machines and serve as the basis for our customers' sustainable business success.



Consulting & Design

Globally available experts for cost-effective solutions



Product & System Support

Fast and reliable, by telephone or on location



Verification & Optimization

Checks and recommendations for increased availability



Upgrade & Retrofits

Uncovers new potential for machines and systems



Training & Education

Employee qualification for increased competitiveness

SICK AT A GLANCE

SICK is a leading manufacturer of intelligent sensors and sensor solutions for industrial applications. With more than 6,500 employees and over 50 subsidiaries and equity investments as well as numerous representative offices worldwide, we are always close to our customers. A unique range of products and services creates the perfect basis for controlling processes securely and efficiently, protecting individuals from accidents and preventing damage to the environment.

We have extensive experience in various industries and understand their processes and requirements. With intelligent sensors, we can deliver exactly what our customers need. In application centers in Europe, Asia and North America, system solutions are tested and optimized in accordance with customer specifications. All this makes us a reliable supplier and development partner.

Comprehensive services round out our offering: SICK LifeTime Services provide support throughout the machine life cycle and ensure safety and productivity.

For us, that is “Sensor Intelligence.”

Worldwide presence:

Australia, Austria, Belgium/Luxembourg, Brazil, Czech Republic, Canada, China, Denmark, Finland, France, Germany, Great Britain, Hungary, India, Israel, Italy, Japan, Mexico, Netherlands, Norway, Poland, Romania, Russia, Singapore, Slovenia, South Africa, South Korea, Spain, Sweden, Switzerland, Taiwan, Turkey, United Arab Emirates, USA

Detailed addresses and additional representatives → www.sick.com